

Chapter 5 - Impedance Matching and Tuning

One of the most important and fundamental two-port networks that microwave engineers design is a **lossless matching network** (otherwise known as an **impedance transformer**).

HO: MATCHING NETWORKS

Q: *In microwave circuits, a source and load are connected by a transmission line. Can we implement matching networks in transmission line circuits?*

A: HO: MATCHING NETWORKS AND TRANSMISSION LINES

Q: *These matching networks seem too good to be true—can we really design and construct them to provide a perfect match?*

A: We can easily provide a near perfect match at precisely one frequency.

But, since lossless matching and transmission lines are made of entirely **reactive elements** (not to mention the reactive components of source and load impedance), we find that **changing** the frequency will typically “**unmatch**” our circuit!

Thus, a difficult challenge for any microwave design engineer is to design a **wideband** matching network—a matching network that provides an “**adequate**” match over a wide range of frequencies.

Generally speaking, matching network design requires a **trade-off** between these for desirable attributes:

1. *Bandwidth*
2. *Complexity*
3. *Implementation*
4. *Adjustability*

5.1 - Matching with Lumped Elements

Reading Assignment: *pp. 222-228*

Now let's begin to examine how matching networks are **built!**

We begin with the **simplest** solution: An **L-network**, consisting of a **single capacitor** and a **single inductor**.

Q: *Just two elements! That seems simple enough. Do we always use these L-networks when constructing lossless matching networks?*

A: Nope. L-networks have **two** major drawbacks:

1. They are **narrow-band**.
2. Capacitors and inductors are **difficult to make** at microwave frequencies!

Now, let's see how these L-networks actually **work**:

HO: L-NETWORK ANALYSIS

Matching Networks

Consider again the problem where a **passive load** is attached to an **active source**:

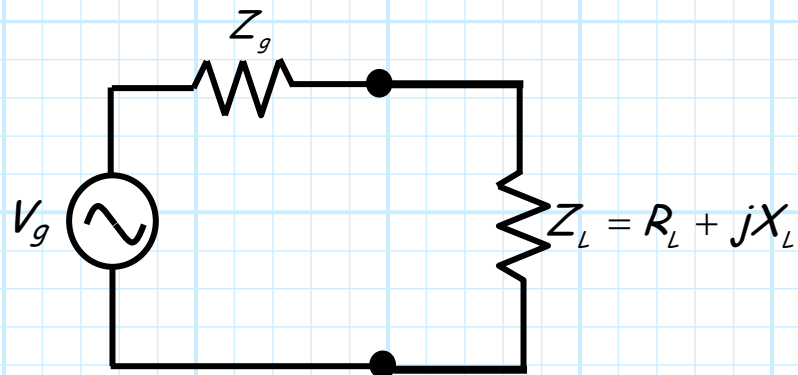

The load will **absorb power**—power that is **delivered** to it by the **source**.

$$\begin{aligned}
 P_L &= \frac{1}{2} \operatorname{Re} \{ V_L I_L^* \} \\
 &= \frac{1}{2} \operatorname{Re} \left\{ \left(V_g \frac{Z_L}{Z_g + Z_L} \right) \left(\frac{V_g}{Z_g + Z_L} \right)^* \right\} \\
 &= \frac{1}{2} |V_g|^2 \frac{\operatorname{Re} \{ Z_L \}}{|Z_g + Z_L|^2} \\
 &= \frac{1}{2} |V_g|^2 \frac{R_L}{|Z_g + Z_L|^2}
 \end{aligned}$$

Recall that the power delivered to the load will be **maximized** (for a given V_g and Z_g) if the load impedance is equal to the **complex conjugate** of the source impedance ($Z_L = Z_g^*$).

We call this maximum power the **available power** P_{avl} of the **source**—it is, after all, the **largest** amount of power that the source can **ever** deliver!

$$\begin{aligned}
 P_L^{max} &\doteq P_{avl} \\
 &= \frac{1}{2} |V_g|^2 \frac{R_g}{|Z_g + Z_g^*|^2} \\
 &= \frac{1}{2} |V_g|^2 \frac{R_g}{|2R_g|^2} \\
 &= \frac{|V_g|^2}{8 R_g}
 \end{aligned}$$

- * Note the available power of the **source** is dependent on **source** parameters **only** (i.e., V_g and R_g). This makes sense! Do you see why?
- * Thus, we can say that to “take full advantage” of all the available power of the source, we must to make the load impedance the complex conjugate of the source impedance.
- * Otherwise, the power delivered to the load will be less than power made available by the source! In other “words”:

$$P_L \leq P_{avl}$$

Q: *But, you said that the load impedance typically models the input impedance of some useful device. We **don't** typically get to "select" or adjust this impedance—it is what it is. Must we then simply **accept** the fact that the delivered power will be less than the available power?*



A: NO! We can in fact modify our circuit such that all available source power is delivered to the load—**without** in any way **altering** the impedance value of that load!

To accomplish this, we must insert a **matching network** between the source and the load:

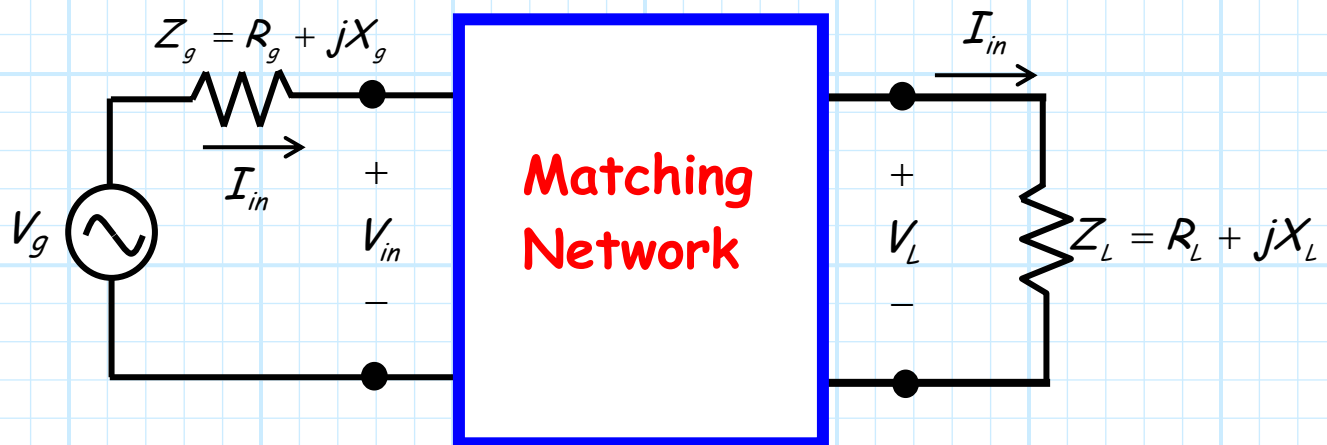

The sole purpose of this matching network is to "transform" the load impedance into an input impedance that is **conjugate matched** to the source! I.E.:

$$Z_{in} = \frac{V_{in}}{I_{in}} = Z_g^*$$

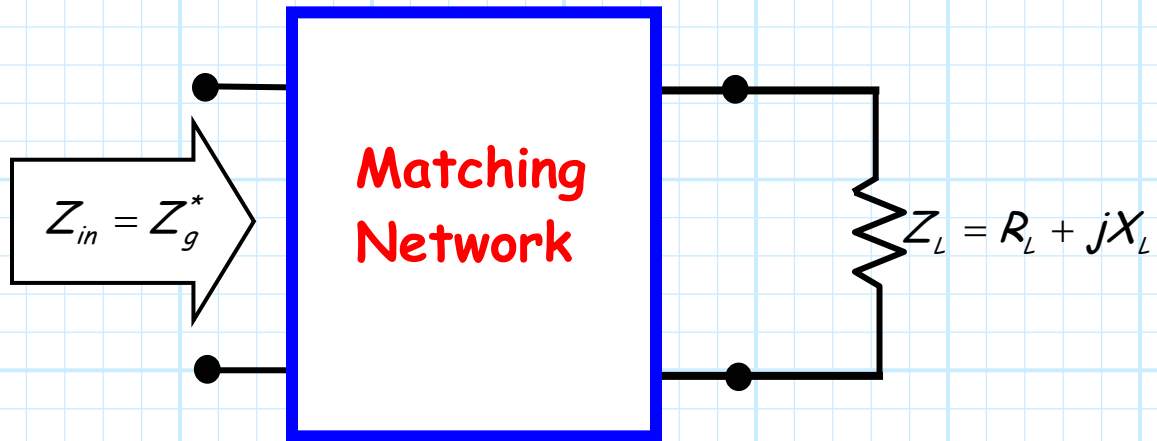

Because of this, **all** available source power is delivered to the input of the matching network (i.e., delivered to Z_{in}):

$$P_{in} = P_{avl}$$

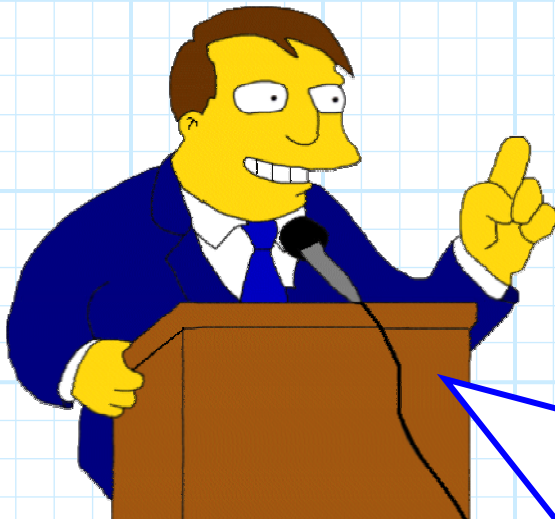

Q: *Wait just one second! The matching network ensures that **all** available power is delivered to the **input** of the matching network, but that does **not** mean (necessarily) that this power will be delivered to the **load** Z_L . The power delivered to the load **could** still be **much less** than the available power!*

A: True! To ensure that the **available power** delivered to the input of the matching network is **entirely** delivered to the **load**, we must construct our matching network such that it **cannot absorb any power**—the matching network must be **lossless!**

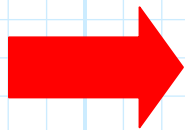

We must construct our matching network entirely with **reactive elements!**

Examples of reactive elements include inductors, capacitors, transformers, as well as lengths of **lossless transmission lines**.

Thus, constructing a proper lossless matching network will lead to the **happy** condition where:

$$P_L = P_{in} = P_{avl}$$

- * Note that the design and construction of this lossless network will depend on **both** the value of source impedance Z_g and load impedance Z_L .
- * However, the matching network does **not physically alter** the values of either of these two quantities—the source and load are left physically unchanged!

Now, let's consider the matching network from a **different perspective**. Instead of defining it in terms of its **input impedance** when attached the **load**, let's describe it in terms of its **output impedance** when attached to the **source**:

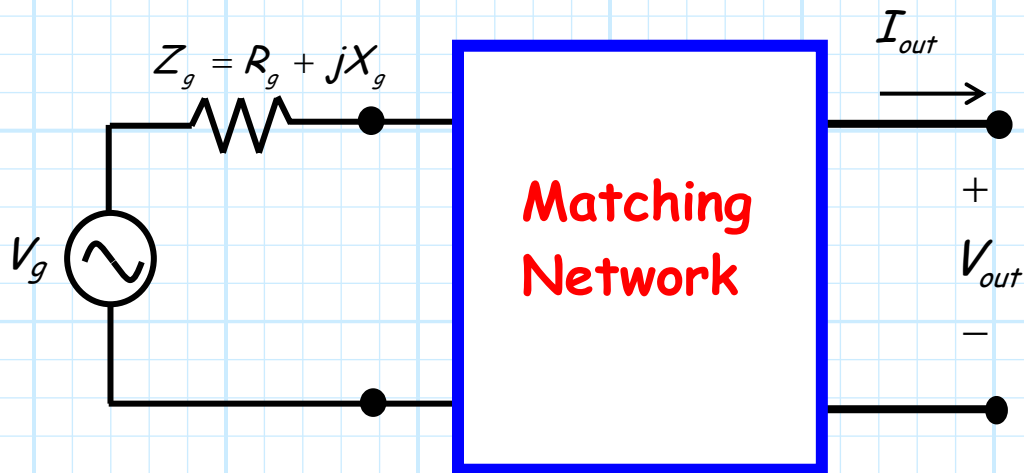

This "new" source (i.e., the original source with the matching network attached) can be expressed in terms of its **Thevenin's equivalent circuit**:

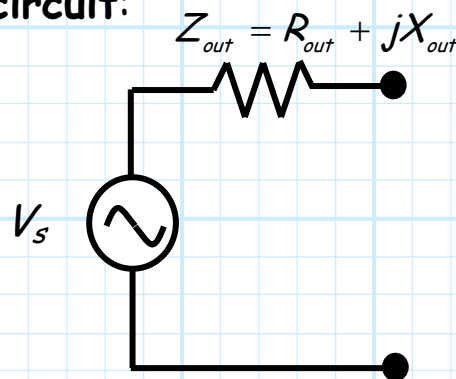

This equivalent circuit can be determined by first evaluating (or measuring) the **open-circuit output voltage** V_{out}^{oc} :

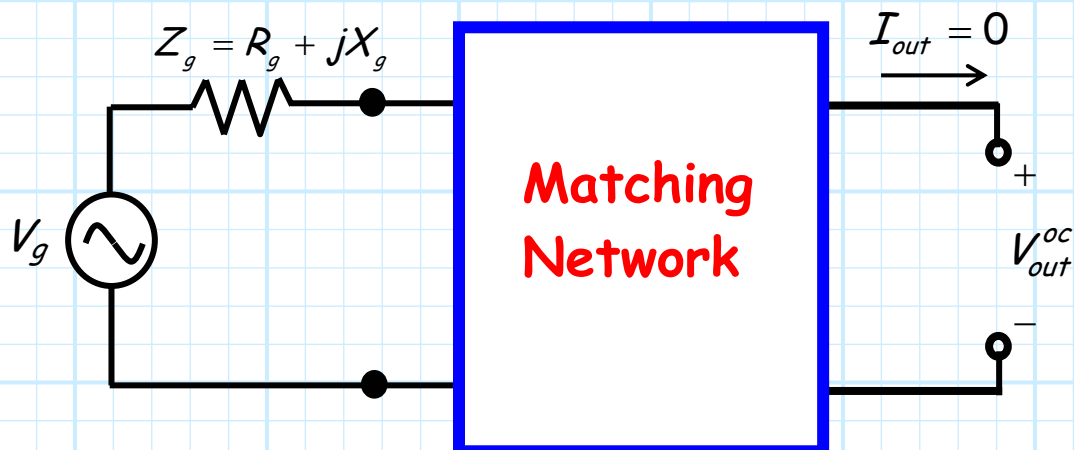

And likewise evaluating (or measuring) the **short-circuit output current** I_{out}^{sc} :

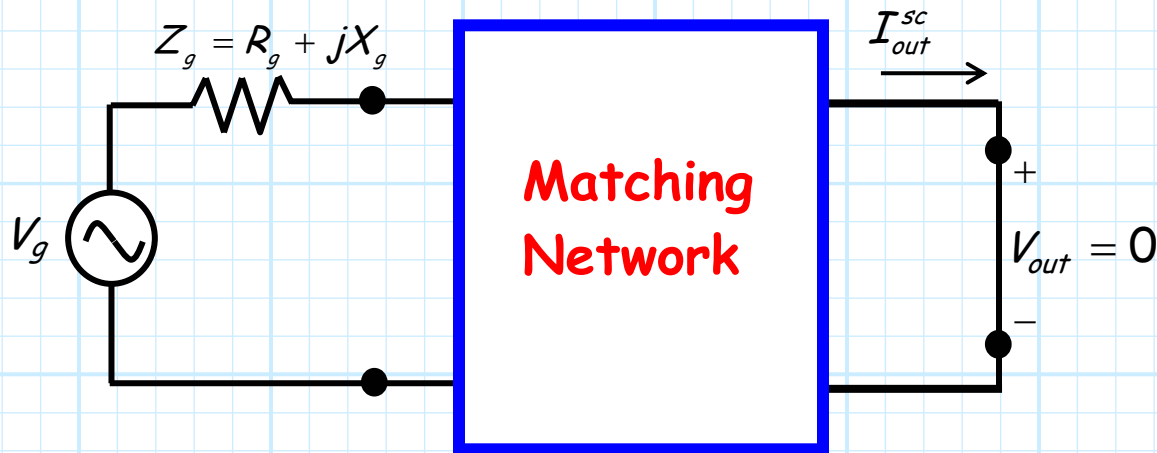

From these two values (V_{out}^{oc} and I_{out}^{sc}) we can determine the **Thevenin's equivalent source**:

$$V_s = V_{out}^{oc} \quad Z_{out} = \frac{V_{out}^{oc}}{I_{out}^{oc}}$$

Note that in general that $V_s \neq V_g$ and $Z_{out} \neq Z_g$ —the matching network "transforms" **both** the values of both the impedance **and** the voltage source.

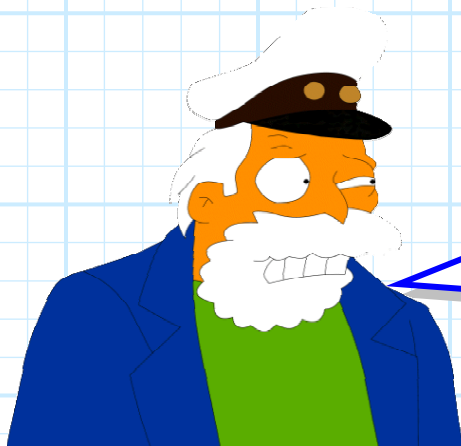

Q: Arrrrgg! Doesn't that mean that the **available power** of this "transformed" source will be **different** from the original?

A: Nope. **If** the matching network is **lossless**, the available power of this equivalent source is **identical** to the available power of the original source—the lossless matching network does **not** alter the available power!

Now, for a **properly** designed, **lossless** matching network, it turns out that (as **you** might have expected!) the output impedance Z_{out} is equal to the **complex conjugate** of the load impedance. I.E.:

$$Z_{out} = Z_L^*$$

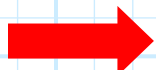
 The source and load are again matched!

Thus, we can look at the matching network in two equivalent ways:

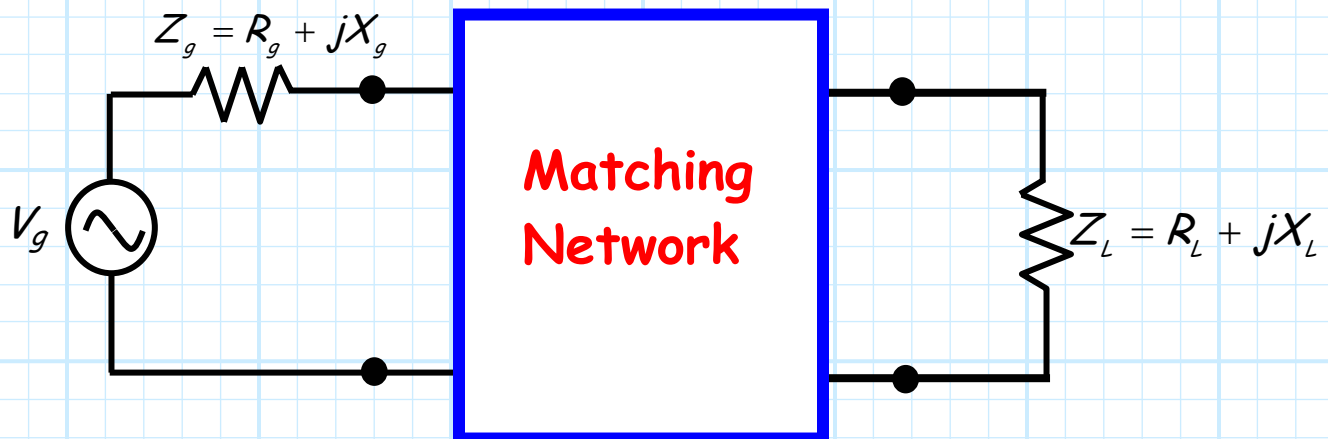

1. As a network attached to a load, one that "transforms" its impedance to Z_{in} —a value matched to the source impedance Z_g :

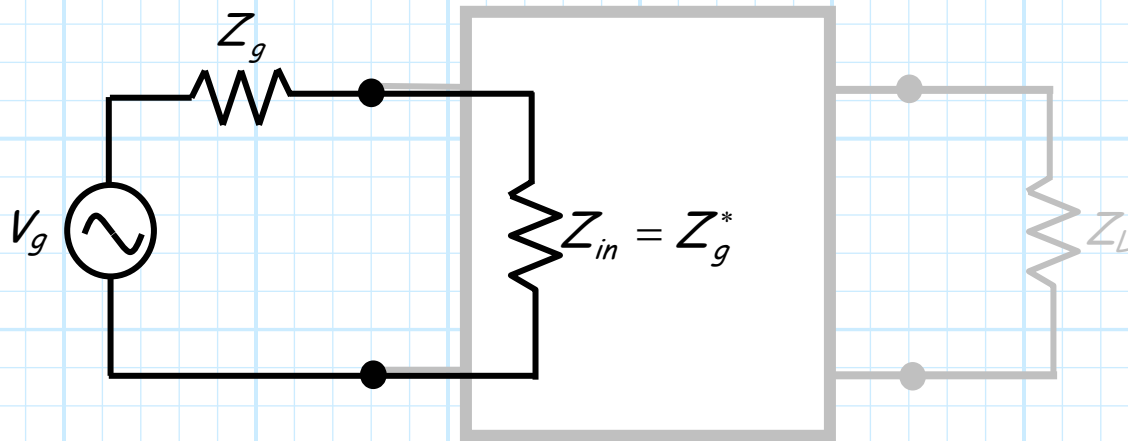

2. Or, as network attached to a source, one that “transforms” its impedance to Z_{out} —a value matched to the load impedance Z_L :

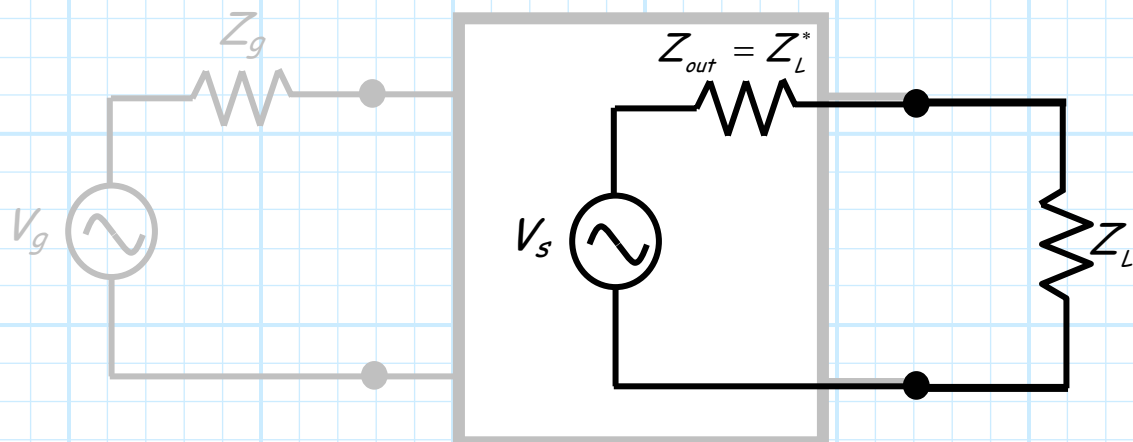

Either way, the source and load impedance are conjugate matched—all the available power is delivered to the load!

Matching Networks and Transmission Lines

Recall that a primary purpose of a transmission line is to allow the transfer of **power** from a source to a load.

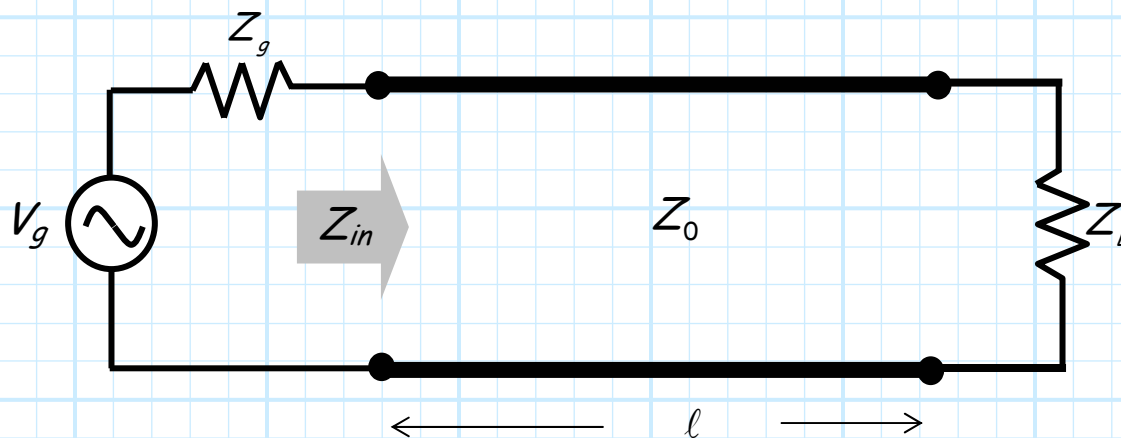

Q: So, say we directly connect an **arbitrary** source to an **arbitrary** load via a length of transmission line. Will the power delivered to the load be equal to the **available power** of the source?

A: Not likely! Remember we determined earlier that the efficacy of power transfer depends on:

1. the source impedance Z_g .
2. load impedance Z_L .
3. the transmission line characteristic impedance Z_0 .

4. the transmission line length ℓ .

Recall that **maximum** power transfer occurred only when these four parameters resulted in the **input impedance** of the transmission line being equal to the **complex conjugate** of the **source impedance** (i.e., $Z_{in}^* = Z_g$).

It is of course **unlikely** that the very **specific** conditions of a **conjugate match** will occur if we simply connect a length of transmission line between an **arbitrary** source and load, and thus the power delivered to the load will generally be **less** than the **available power** of the source.

Q: *Is there any way to use a **matching network** to fix this problem? Can the power delivered to the load be increased to **equal** the available power of the source if there is a transmission line connecting them?*

A: There sure is! We can likewise construct a matching network for the case where the source and load are connected by a **transmission line**.

For example, we can construct a network to transform the **input impedance** of the transmission line into the complex conjugate of the **source impedance**:

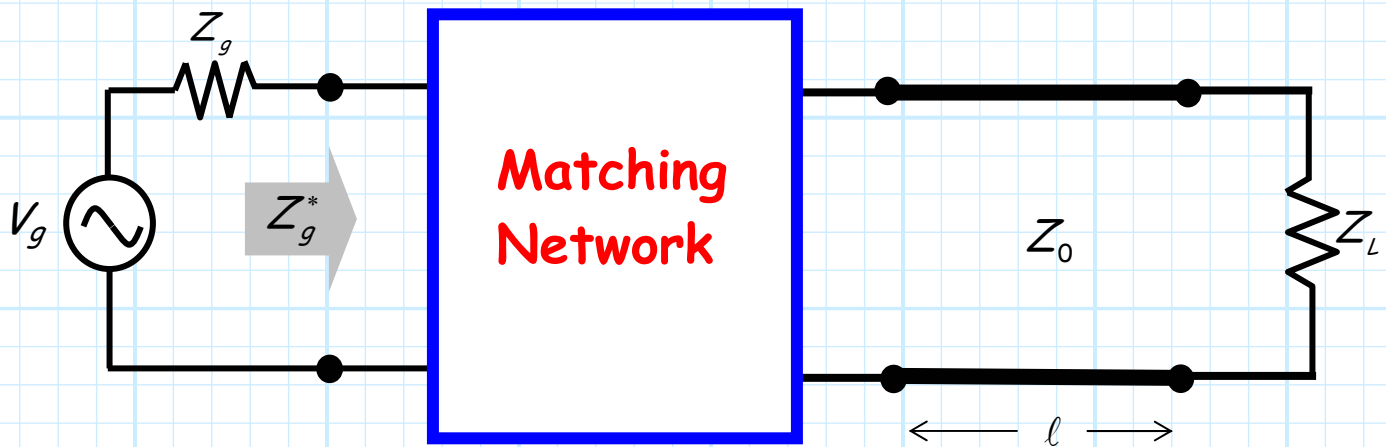

Q: *But, do we have to place the matching network between the source and the transmission line?*

A: Nope! We could also place a (different) matching network between the transmission line and the load.

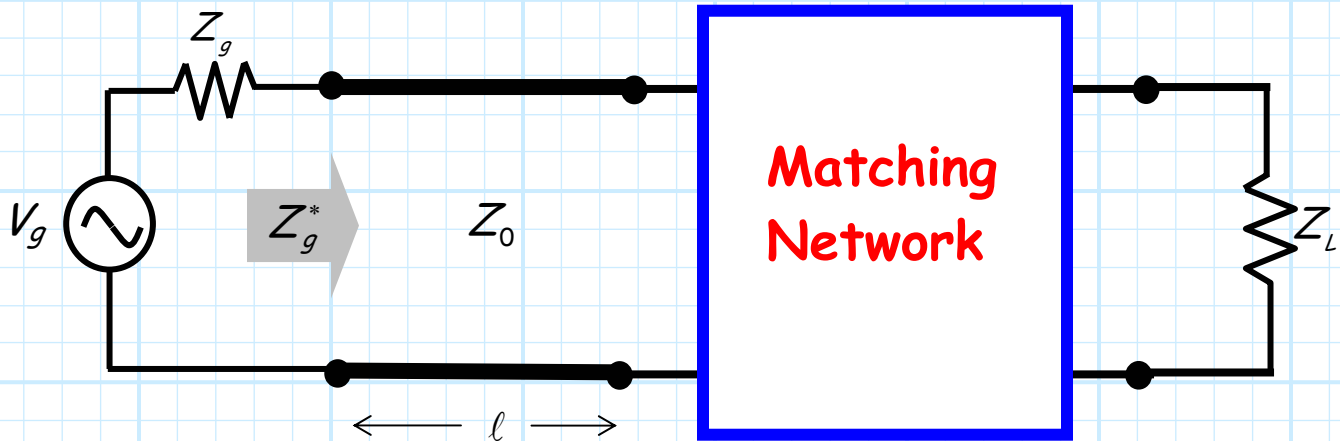

In either case, we find that at **any** and **all** points along this matched circuit, the output impedance of the equivalent **source** (i.e., looking left) will be equal to the **complex conjugate** of the **input impedance** (i.e., looking right).

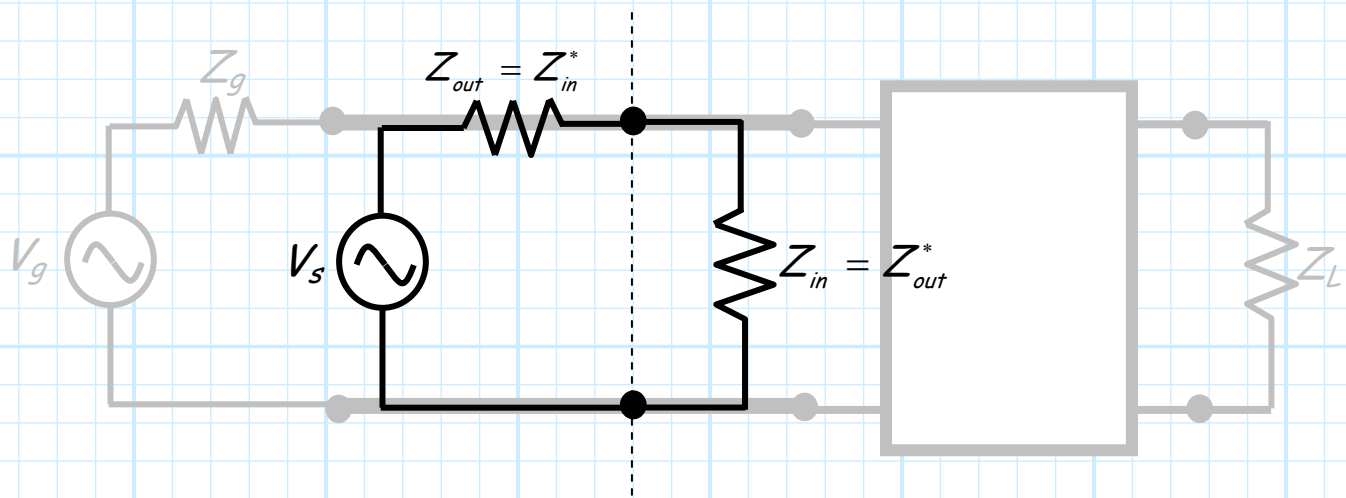

Q: So which method should we choose? Do engineers typically place the matching network between the source and the transmission line, or place it between the transmission line and the load?

A: Actually, the typical solution is to do **both**!

We find that often there is a matching network between the a source and the transmission line, **and** between the line and the load.

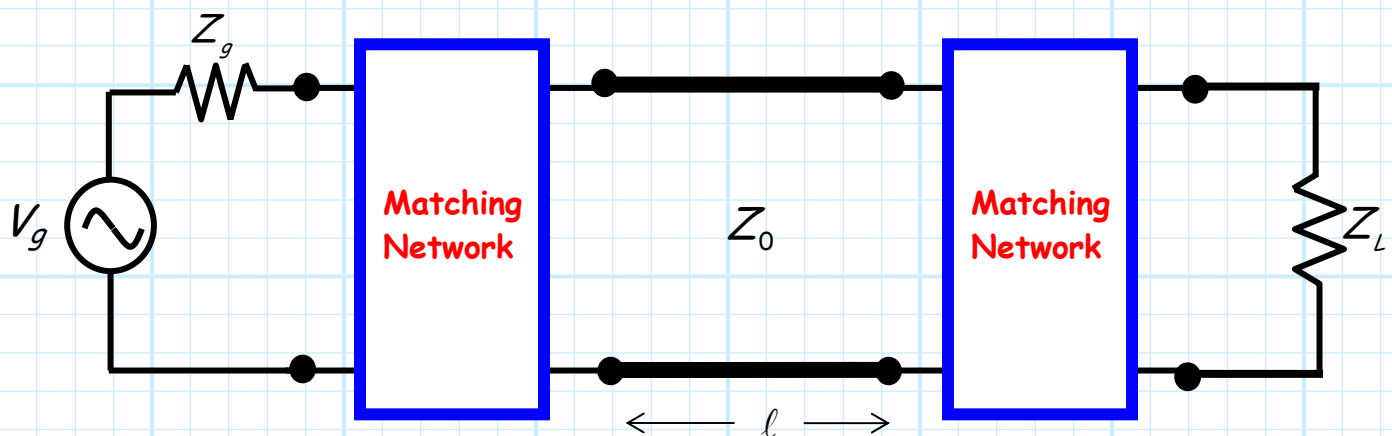

The first network matches the **source** to the **transmission line**—in other words, it transforms the **output impedance** of the equivalent source to a value numerically equal to **characteristic impedance Z_0** :

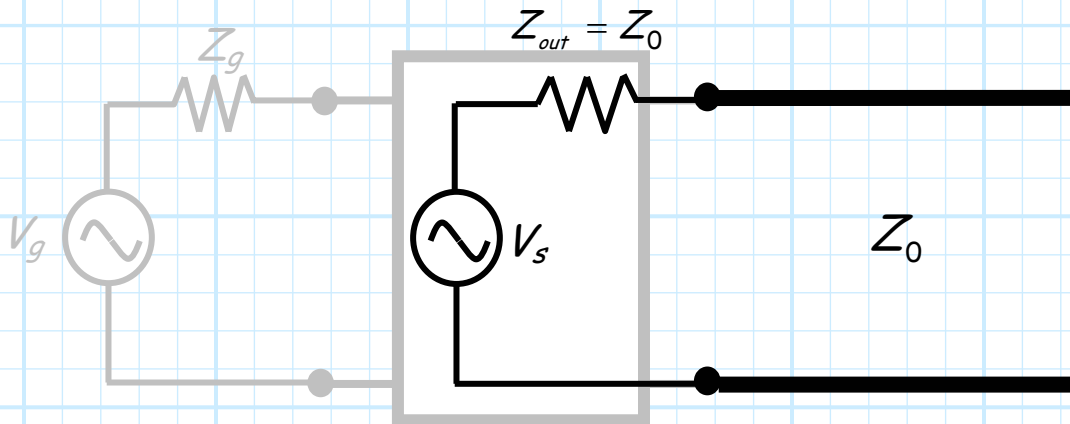

The second network matches the **load** to the **transmission line**—in other words it transforms the **load impedance** to a value numerically equal to **characteristic impedance Z_0** :

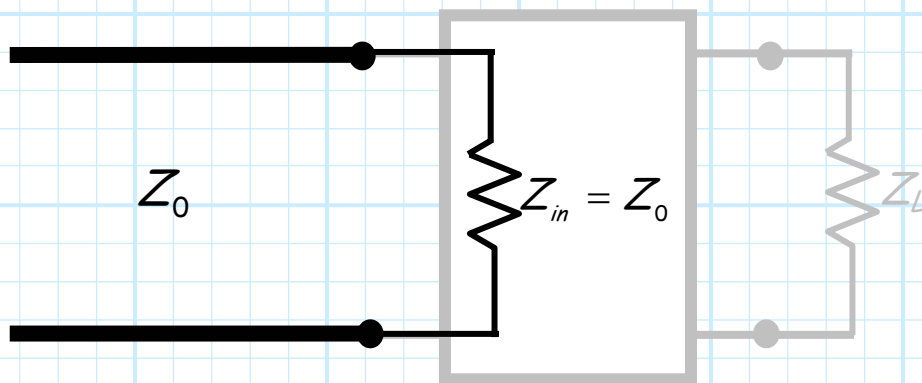

Q: *Yikes! Why would we want to build **two** separate matching networks, instead of just **one**?*

A: By using two separate matching networks, we can **decouple** the design problem. Recall again that the design of a **single** matching network solution would depend on four separate parameters:

1. the source impedance Z_g .
2. load impedance Z_L .
3. the transmission line characteristic impedance Z_0 .
4. the transmission line length ℓ .

Alternatively, the design of the network matching the **source** and **transmission line** depends on **only**:

1. the source impedance Z_g .
2. the transmission line characteristic impedance Z_0 .

Whereas, the design of the network matching the **load** and **transmission line** depends on **only**:

1. the source impedance Z_L .
2. the transmission line characteristic impedance Z_0 .

Note that **neither** design depends on the transmission line **length** ℓ !

Q: *How is that possible?*

A: Remember the case where $Z_g = Z_0 = Z_L$. For that **special** case, we found that a conjugate match was the result—**regardless** of the transmission line length.

Thus, by matching the source to line impedance Z_0 **and** likewise matching the load to the line impedance, a conjugate match is **assured**—but the **length** of the transmission line does **not** matter!

In fact, the typically problem for microwave engineers is to match a load (e.g., device input impedance) to a **standard** transmission line impedance (typically $Z_0 = 50\Omega$); **or** to independently match a source (e.g., device output impedance) to a **standard** line impedance.

A **conjugate match** is thus obtained by connecting the two with a transmission line of **any length**!

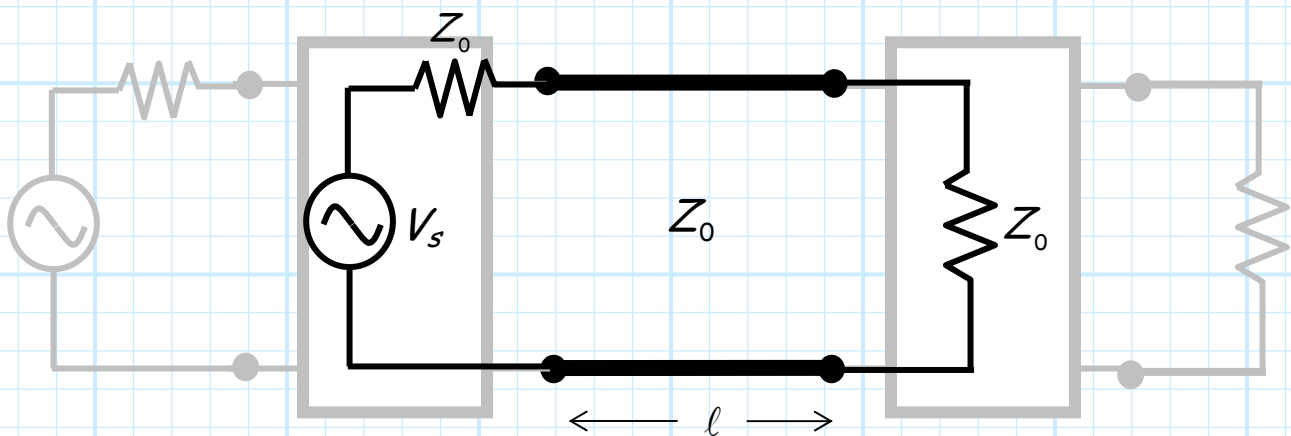

L-Network Analysis

Consider the **first** matching L-network, which we shall denote as matching **network (A)**:

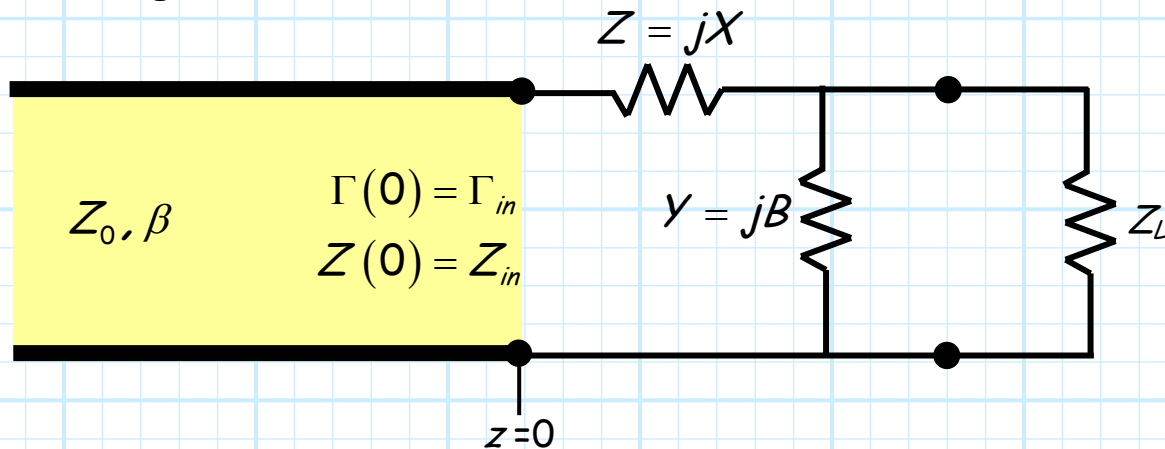

Note that this matching network consists of just **two** lumped elements, which must be **purely reactive**—in other words, a **capacitor** and an **inductor**!

To make $\Gamma_{in} = 0$, the **input impedance** of the network must be:

$$Z_{in} = Z_0$$

Note that using **basic** circuit analysis we find that this input impedance is:

$$\begin{aligned} Z_{in} &= jX + \frac{\left(\frac{1}{jB}\right)Z_L}{\frac{1}{jB} + Z_L} \\ &= jX + \frac{Z_L}{1 + jBZ_L} \end{aligned}$$

Note that a **matched** network, with $Z_{in} = Z_0$, means that:

$$\operatorname{Re}\{Z_{in}\} = Z_0 \quad \text{AND} \quad \operatorname{Im}\{Z_{in}\} = 0$$

Note that there are **two** equations.

This works out well, since we have **two** unknowns (B and X)!

Essentially, the L-network matching network can be viewed as consisting of **two distinct parts**, each attempting to satisfy a specific requirement.

Part 1: Selecting $Y = jB$

Since the shunt element Y and Z_L are in **parallel**, we can combine them into one element that we shall call Y_1 :

$$Y_1 \doteq Y + \frac{1}{Z_L} = jB + Y_L$$

The impedance of this element is therefore:

$$Z_1 = \frac{1}{Y_1} = \frac{1}{jB + Y_L} = \frac{Z_L}{Z_L + jB Z_L}$$

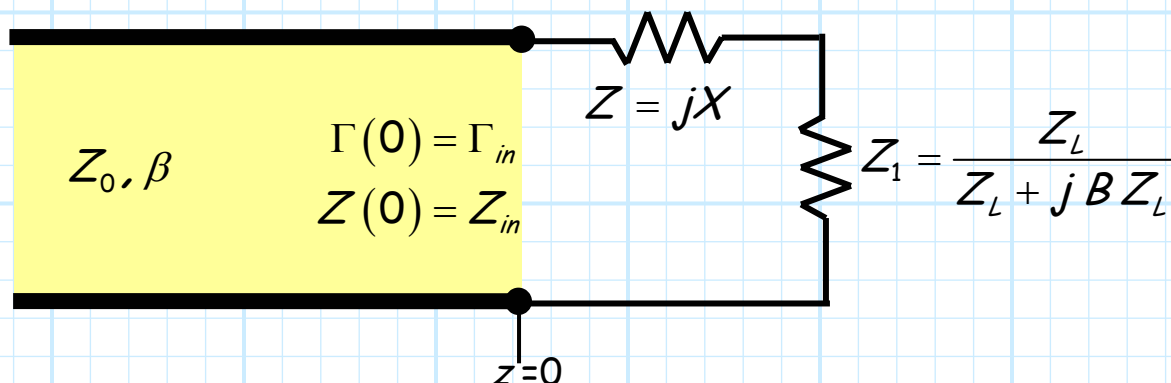

To achieve a perfect match, we must set the value of susceptance B such that:

$$\operatorname{Re}\{Z_1\} = \operatorname{Re}\left\{\frac{Z_L}{Z_L + jBZ_L}\right\} = Z_0$$

Thus, if B is properly selected:

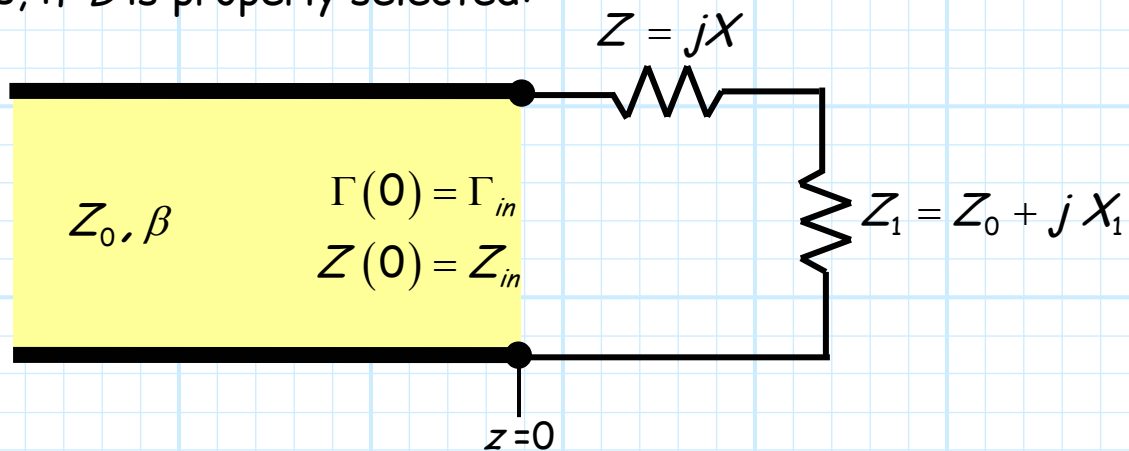

Hopefully, the second part of the matching is now very obvious to you!

Part 2: Selecting $Z = jX$

Note that the impedance $Z_1 = Z_L \parallel 1/jB$ has the ideal real value of Z_0 . However, it likewise possesses an **annoying** imaginary part of:

$$X_1 = \operatorname{Im}\{Z_1\} = \operatorname{Im}\left\{\frac{Z_L}{Z_L + jBZ_L}\right\}$$

However, this imaginary component is easily removed by setting the **series** element $Z = jX$ to its equal but **opposite** value!

I.E.;

$$X = -X_1 = -\text{Im} \left\{ \frac{Z_L}{Z_L + jBZ_L} \right\}$$

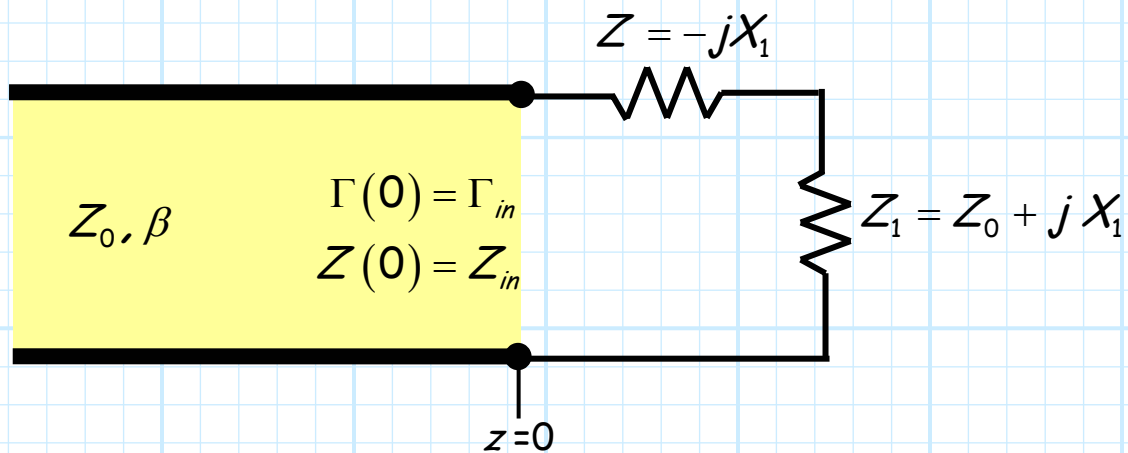

Thus, we find that:

$$\begin{aligned} Z_{in} &= Z + Z_1 \\ &= -jX_1 + Z_0 + jX_1 \\ &= Z_0 \end{aligned}$$

We have created a **perfect match!**

Going through this complex algebra, we can solve for the **required** values X and B to **satisfy** these two equations—to create a **matched** network!

$$B = \frac{X_L \pm \sqrt{R_L/Z_0} \sqrt{R_L^2 + X_L^2 - Z_0 R_L}}{R_L^2 + X_L^2}$$

and,

$$X = \frac{1}{B} + \frac{X_L Z_0}{R_L} - \frac{Z_0}{B R_L}$$

where $Z_L = R_L + jX_L$.

Note:

- 1) Because of the \pm , there are **two** solutions for B (and thus X).
- 2) For jB to be purely imaginary (i.e., reactive), B must be **real**. From the term:

$$\sqrt{R_L^2 + X_L^2 - Z_0 R_L}$$

in the expression for B , we note that R_L **must** be greater than Z_0 ($R_L > Z_0$) to insure that B and thus X is real.

In other words, this matching network can only be used when $R_L > Z_0$. Notice that this condition means that the normalized load z'_L lies **inside** the $r = 1$ circle on the Smith Chart!

Now let's consider the **second** of the two L-networks, which we shall call **network (B)**. Note it **also** is formed with just two lumped elements.

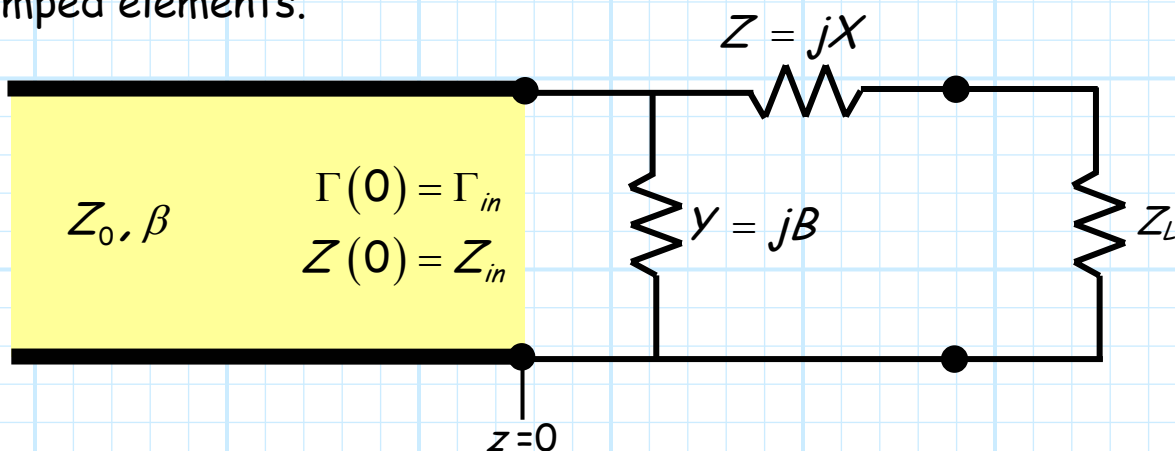

To make $\Gamma_{in} = 0$, the **input admittance** of the network must be:

$$Y_{in} = Y_0$$

Note from circuit theory that the input **admittance** for this network is:

$$Y_{in} = jB + \frac{1}{jX + Z_L}$$

Therefore a **matched** network, with $Y_{in} = Y_0$, is described as:

$$\text{Re}\{Y_{in}\} = Y_0 \quad \text{AND} \quad \text{Im}\{Y_{in}\} = 0$$

For this design, we set the value of $Z = jX$ such that the admittance Y_1 :

$$Y_1 \doteq \frac{1}{Z + Z_L} = \frac{1}{jX + Z_L}$$

has a real part equal to Y_0 :

$$Y_0 = \text{Re}\{Y\}_1 = \text{Re}\left\{\frac{1}{jX + Z_L}\right\}$$

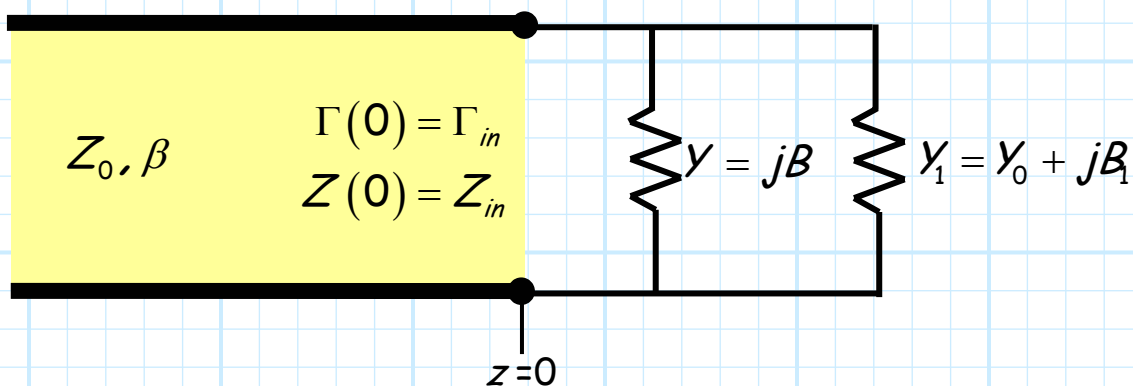

Now, it is evident that a perfect match will occur if the shunt element $Y = jB$ is set to "cancel" the reactive component of Y_1 :

$$B = -\text{Im}\{Y\}_1 = -\text{Im}\left\{\frac{1}{jX + Z_L}\right\}$$

So that we find:

$$Y_{in} = Y + Y_1 = -jB_1 + (Y_0 + jB_1) = Y_0$$

A perfect match!

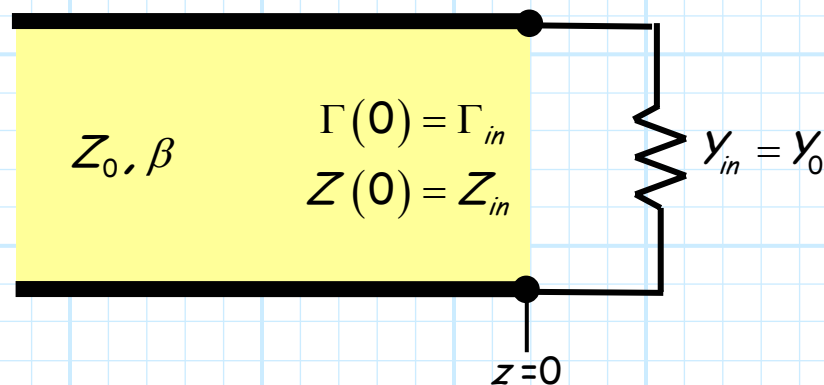

With these two equations, we can directly solve for the **required** values X and B for a **matched** network:

$$X = \pm \sqrt{R_L(Z_0 - R_L)} - X_L$$

and,

$$B = \pm \frac{\sqrt{(Z_0 - R_L)/R_L}}{Z_0}$$

where $Z_L = R_L + jX_L$.

Note:

- 1) Because of the \pm , there are **two** solutions for B (and thus X).
- 2) For jB and jX to be purely imaginary (i.e., reactive), B and X must be **real**. We note from the term:

$$(Z_0 - R_L)$$

that R_L must be **less** than Z_0 ($R_L < Z_0$) to insure that B and thus X are real.

In other words, this matching network can **only** be used when $R_L < Z_0$. Notice that this condition means that the normalized load z'_L lies **outside** the $r = 1$ circle on the Smith Chart!

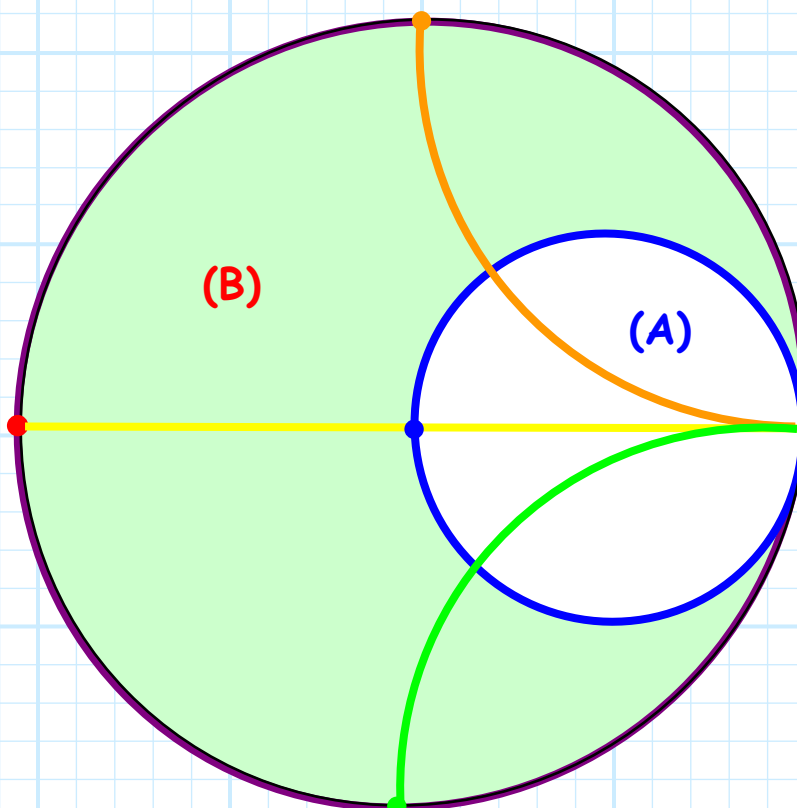

Once the values of X and B are found, we can determine the required values of inductance L and/or capacitance C , for the signal frequency ω_0 !

Recall that:

$$X = \begin{cases} \omega_0 L & \text{if } X > 0 \\ \frac{-1}{\omega_0 C} & \text{if } X < 0 \end{cases}$$

and that:

$$B = \begin{cases} \omega_0 C & \text{if } B > 0 \\ \frac{-1}{\omega_0 L} & \text{if } B < 0 \end{cases}$$

Make sure that **you** see and know why these equations are true.

As a result, we see that the reactance or susceptance of the elements of our L-network will have the proper values for matching at precisely **one** and **only** one frequency!

And this frequency **better** be the signal frequency ω_0 !

If the signal frequency **changes** from this design frequency, the reactance and susceptance of the matching network inductors and capacitors will likewise change. The circuit will **no longer** be matched.

This matching network has a **narrow bandwidth!**

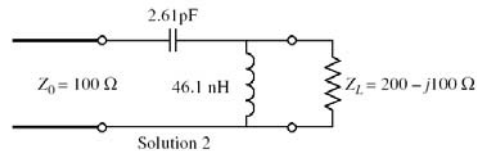
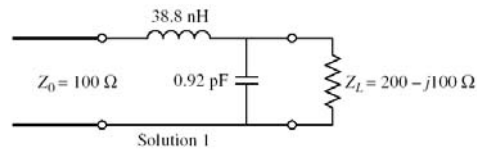

(b)

An L-Network Design Example

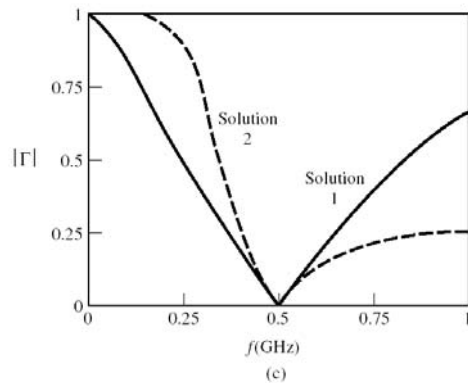

One other problem; it becomes **very** difficult to build quality **lumped** elements with useful values past 1 or 2 GHz. Thus, L-Network solutions are generally applicable only in the **RF region** (i.e., < 2GHz).

